

BRANT AREA INTEGRATED REGIONAL RESOURCE PLAN

Part of the Burlington-Naticoke Planning Region | April 28, 2015



Integrated Regional Resource Plan

Brant Area

This Integrated Regional Resource Plan (“IRRP”) was prepared by the IESO pursuant to the terms of its Ontario Energy Board licence, EI-2013-0066.

This IRRP was prepared on behalf of the Brant Area Working Group, which included the following members:

- Independent Electricity System Operator
- Brant County Power Inc.
- Brantford Power Inc.
- Hydro One Networks Inc. (Distribution) and
- Hydro One Networks Inc. (Transmission)

The Brant Area Working Group assessed the adequacy of electricity supply to customers in the Brant Area over a 20-year period; developed a flexible, comprehensive, integrated plan that considers opportunities for coordination in anticipation of potential demand growth scenarios and varying supply conditions in the Brant Area; and developed an implementation plan for the recommended options, while maintaining flexibility in order to accommodate changes in key assumptions over time.

Brant Area Working Group members agree with the IRRP’s recommendations and support implementation of the plan through the recommended actions. Brant Area Working Group members do not commit to any capital expenditures and must still obtain all necessary regulatory and other approvals to implement recommended actions.

Copyright © 2015 Independent Electricity System Operator. All rights reserved.

Table of Contents

- 1. Introduction1**
- 2. The Integrated Regional Resource Plan3**
 - 2.1 Near-Term and Medium-Term Plan (2014 through 2023).....3
 - 2.2 Near- and Medium-Term Actions in Support of Long-Term Plan (2024 through 2033).....6
- 3. Development of the IRRP8**
 - 3.1 The Regional Planning Process.....8
 - 3.2 The IESO’s Approach to Regional Planning..... 11
 - 3.3 Brant Area Working Group and IRRP Development 12
- 4. Background and Study Scope..... 13**
- 5. Demand Forecast.....15**
 - 5.1 Historical Demand..... 15
 - 5.2 Demand Forecast Methodology 15
 - 5.2.1 Near- and Medium-Term (2014 through 2023) 16
 - 5.2.2 Longer Demand Forecast (2024 through 2033)..... 17
 - 5.3 Gross Demand Forecast..... 18
 - 5.4 Conservation Assumed in the Forecast..... 18
 - 5.5 Distributed Generation Assumed in the Forecast..... 19
 - 5.6 Planning Forecasts.....20
 - 5.6.1 Total Demand Forecast in Brant Area..... 20
 - 5.6.2 Long-Term (2024 through 2033)..... 21
 - 5.6.3 Sub-system Forecasts 22
- 6. Electricity System Needs.....24**
 - 6.1 Needs Assessment Methodology 24
 - 6.2 Ontario Resource and Transmission Assessment Criteria 24
 - 6.3 Near- and Medium-Term Needs 25
 - 6.3.1 Need for Additional Supply Capacity 25
 - 6.3.2 Load Restoration Needs..... 26
 - 6.3.3 Conclusion Near- and Medium-Term Electricity Needs..... 26
 - 6.4 Long-Term Needs.....26

7. Near- and Medium-Term Plan.....	28
7.1 Alternatives for Meeting Near- and Medium-Term Needs.....	28
7.1.1 Conservation.....	28
7.1.2 Local Generation.....	29
7.1.3 Transmission.....	29
7.1.4 Distribution Options	30
7.2 Recommended Near- and Medium-Term Plan.....	30
7.3 Implementation of Near- and Medium-Term Plan.....	32
8. Long-Term Plan (2024 through 2033)	35
8.1 Approaches to Meeting Long-Term Needs	36
8.1.1 Delivering Provincial Resources	38
8.1.2 Large, Localized Generation.....	38
8.1.3 Community Self-Sufficiency.....	39
8.2 Recommended Actions in Support of Long-Term Plan.....	39
8.3 Recommended Actions and Implementation.....	40
9. Community, Aboriginal and Stakeholder Engagement.....	42
10. Conclusion	46

List of Figures

Figure 2-1: Brant Area Electricity System 4

Figure 3-1: Levels of Electricity System Planning 10

Figure 3-2: Steps in the IRRP Process..... 12

Figure 4-1: Brant Area and Vicinity 13

Figure 4-2: Brant Area Sub-systems 14

Figure 5-1: Brant Area Historical Electricity Demand 15

Figure 5-2: Development of Demand Forecasts 17

Figure 5-3: Brant Area Total Demand Forecast 20

Figure 5-4: Brant TS and Powerline MTS Forecast..... 22

Figure 5-5: Brantford TS Planning Forecast..... 23

Figure 6-1: Historical and Forecast Electricity Demand and Supply Capability in the Brant-
Powerline Sub-system 25

Figure 7-1: Brant-Powerline Sub-system Planning Forecast and LMC 32

Figure 8-1: Approaches to Meeting Long-Term Needs 37

Figure 9-1: Summary of Brant IRRP Community Engagement Process..... 43

List of Tables

Table 5-1: Near-Term Industrial Load 21

Table 6-1: Capacity Gap in 2033 under Higher-Growth Scenario..... 27

Table 7-1: Implementation of Near- and Medium-Term Plan for the Brant Area 34

Table 8-1: Implementation of Near-Term Actions in Support of the Long-Term Plan for the
Brant Area 41

List of Appendices

Appendix A: Demand Forecasts

Appendix B: Technical Studies

Appendix C: Ontario Resource and Transmission Assessment Criteria

Appendix D: Conservation

Appendix E: Transmission

Appendix F: Community Engagement

List of Abbreviations

Abbreviation	Description
C&S	Codes and Standards
CDM	Conservation and Demand Management
CEP	Community Energy Plan
CHP	Combined Heat and Power
CHPSOP	Combined Heat and Power Standard Offer Program
DG	Distributed Generation
DR	Demand Response
EE	Energy Efficiency
EA	Environmental Assessment
EM&V	Evaluation, Measurement and Verification
EV	Electric Vehicle
FIT	Feed-in Tariff
GS	Generating Station
IESO	Independent Electricity System Operator
IRRP	Integrated Regional Resource Plan
kV	Kilovolt
LAC	Local Advisory Committee
LDC	Local Distribution Company
LTEP	(2013) Long-Term Energy Plan
LTR	Limited Time Rating
LMC	Load Meeting Capability
MCOD	Maximum Commercial Operation Date
MW	Megawatt
MEP	Municipal Energy Plan
MEP/CEP	Municipal or Community Energy Planning
MTS	Municipal Transformer Station
OEB or Board	Ontario Energy Board
OPA	Ontario Power Authority

Abbreviation	Description
ORTAC	Ontario Resource and Transmission Assessment Criteria
PPS	(Ontario's) Provincial Policy Statement
PPWG	Planning Process Working Group
RIP	Regional Infrastructure Plan
SCGT	Simple-Cycle Gas Turbine
SPS	Special Protection System
TOU	Time-of-Use
TS	Transformer Station
Working Group	Technical Working Group for Brant Area IRRP

1. Introduction

This Integrated Regional Resource Plan (“IRRP”) addresses the electricity needs of the Brant Area (“Area”) over the next 20 years from 2014 to 2033. This report was prepared by the IESO on behalf of a Technical Working Group composed of the IESO, Brant County Power Inc., Brantford Power Inc., Hydro One Distribution, and Hydro One Transmission (“the Working Group”).

The Brant Area encompasses the County of Brant, City of Brantford and surrounding areas. It has an estimated population of over 136,000 people. The electricity demand mix is comprised of residential, commercial and industrial uses. The Brant Area is supplied by the Brant TS, Powerline MTS and Brantford TS.

In Ontario, planning to meet the electrical supply and reliability needs of a large area or region is done through regional electricity planning, a process that was formalized by the Ontario Energy Board (“OEB” or “Board”) in 2013. In accordance with the OEB regional planning process, transmitters, distributors and the IESO are required to carry out regional planning activities for the twenty-one electricity planning regions at least once every five years.

Under the Province’s Growth Plan for the Greater Golden Horseshoe,¹ the Brant Area is expected to experience continued population growth in the coming decades. It continues to attract industrial and commercial customers and create opportunities for future development. This IRRP will help to ensure that the electricity system will support the expected development over the long term.

The Brant Area is a sub-region within the Burlington/Nanticoke region established through the OEB regional planning process. This report therefore contributes to fulfilling the requirements for the Burlington/Nanticoke region as mandated by the OEB. A second sub-region of the Burlington/Nanticoke region consists of the Bronte Area of Oakville and Burlington; this sub-region will be studied as a separate IRRP and is not included in the scope of this IRRP.

This IRRP for Brant identifies and coordinates options to meet electricity needs in the Area over the next 20 years (“study period”) and is sub-divided into the near term (0-5 years, or 2014 through 2018), medium term (6-10 years, or 2019 through 2023) and longer term (11-20 years, or 2024 through 2033). Specifically, this IRRP identifies investments for immediate

¹ *Growth Plan for the Greater Golden Horseshoe, 2006 under the Places to Grow Act, 2005*

implementation to meet near- and medium-term needs in the Area, respecting expected lead times for development. This IRRP also identifies a number of options to meet longer-term needs, but given forecast uncertainty, the longer development lead time and the potential for technological change, the plan maintains flexibility for longer-term options and does not recommend specific projects at this time. Instead, the long-term plan identifies near-term actions to develop alternatives and engage with the community, to gather information and lay the groundwork to meet future needs, should they arise. These actions are intended to be completed before the next IRRP cycle, scheduled for 2020, so that the results of these actions can inform a decision should one be needed at that time.

This report is organized as follows:

- A summary of the recommended plan for the Brant Area is provided in Section 2;
- The process and methodology used to develop the plan are discussed in Section 3;
- The context for electricity planning in the Brant Area and the study scope are discussed in Section 4;
- Demand forecast scenarios, and conservation and distributed generation assumptions, are described in Section 5;
- Near- medium- and long-term electricity needs in the Brant Area are presented in Section 6;
- Options for meeting near- and medium-term needs are assessed and recommendations for the near-term plan are provided in Section 7;
- Alternatives for meeting long-term needs are discussed and actions to support development of the long-term plan are provided in Section 8;
- A summary of community, aboriginal and stakeholder engagement to date in developing this IRRP and moving forward is provided in Section 9; and
- A conclusion is provided in Section 10.

2. The Integrated Regional Resource Plan

The Brant IRRP provides recommendations to address the Area’s forecast electricity needs over the next 20 years, based on application of the IESO’s Ontario Resource and Transmission Assessment Criteria (“ORTAC”). This IRRP identifies forecast electricity needs in the Area over near term (0-5 years, or 2014 through 2018), medium term (6-10 years, or 2019 through 2023) and longer term (11- 20 years, or 2024 through 2033). These planning horizons are distinguished in the IRRP to reflect the different level of commitment required over these time horizons. The plans to address these timeframes are coordinated to ensure consistency. The IRRP was developed based on consideration of planning criteria, including reliability, cost, feasibility, and maximization of the use of the existing electricity system, where it is economic to do so.

This IRRP identifies specific projects for implementation in the near and medium term. This is necessary to ensure that they are in-service in time to address the Area’s more urgent needs, respecting the lead time for development of the recommended infrastructure.

This IRRP identifies a number of alternatives to prepare to meet the Area’s longer-term electricity needs. However, as these needs are forecast to arise in the future, it is not necessary (nor would it be prudent given forecast uncertainty and the potential for technological change) to recommend specific projects at this time. Instead, near-term actions are identified to develop alternatives and engage with the community, to gather information and lay the groundwork for future options. These actions are intended to be completed before the next IRRP cycle so that their results can inform a decision at that time.

2.1 Near-Term and Medium-Term Plan (2014 through 2023)

The first element of the near-term plan is to account for targeted conservation and contracted distributed generation (“DG”). To address urgent supply capacity needs, two transmission projects are also recommended. The development of one of the transmission projects is currently underway; the former OPA issued a letter² to Hydro One Networks Inc.

<p style="text-align: center;">Near-Term Need</p> <ul style="list-style-type: none">• Supply capacity in the Brant-Powerline 115 kV sub-system is inadequate today

²Letter to Hydro One:

<http://www.hydroone.com/RegionalPlanning/Burlington/Documents/OPA Letter - Burlington Nanticoke - Brant.pdf>

("Hydro One") supporting this near-term project in order to ensure it was initiated and brought into service in time to address an urgent need. The second transmission project is under discussion between Brantford Power Inc., Brant County Power Inc. and Hydro One. These projects are described below and their respective locations are shown in Figure 2-1. The estimated cost of these transmission projects is approximately \$13-16 million. Together, these projects can increase the load meeting capability ("LMC") of the 115 kV sub-system from 104 MW to approximately 165 MW. Combined with the other near- and medium-term recommendations, these projects will be sufficient to meet the forecast demand growth until the end of the study period.

Figure 2-1: Brant Area Electricity System



These recommendations meet the near- and medium-term electricity needs of the Brant Area in a timely and cost-effective manner, and were developed with a view to maximizing the use of the existing system.

Recommended Actions

1. Implement conservation and distributed generation and monitor results

The implementation of provincial conservation and DG targets established in the 2013 Long Term Energy Plan ("LTEP") are key components of the near- and medium-term plan for the

Brant Area. In developing the demand forecast, peak-demand impacts associated with the provincial targets were assumed before identifying any residual needs, consistent with the provincial Conservation First policy.³ Conservation resources account for approximately 40% of the forecast demand growth during the first 10 years of the study.

As the provincial conservation targets are energy⁴ based, the IESO with the Area local distribution companies (“LDCs”) will monitor the magnitude of the peak demand savings resulting from these targets in the Brant Area. This will be an important element of the near-term plan, and will also lay the foundation for the long-term plan by gauging actual performance of specific conservation measures, and assessing potential in the Area for further conservation efforts.

Provincial programs that encourage the development of distributed generation, such as the Feed-in-Tariff (“FIT”), microFIT, and Combined Heat and Power Standard Offer (“CHPSOP”) programs, can also contribute to reducing peak demand in the Region, dependent, in part, on local interest and opportunities for development. Existing and committed distributed generation impacts were also assumed before identifying needs for the Area. It is expected that distributed generation resources will reduce the gross forecast for the Area by approximately 5 % for the study period. The LDCs and the IESO will continue their activities to support DG initiatives where appropriate and monitor their impacts.

2. Install capacitor banks at Powerline MTS

To meet the urgent need to provide capacity relief to the Area’s 115 kV supply pocket the Working Group recommended the installation of 30 MVAR of capacitor banks at Powerline MTS. The estimated cost from Brantford Power and Brant County Power for this project is approximately \$1-million. These capacitor banks are expected to be in-service for the summer of 2015, and will provide additional capacity of 21 MW to the Brant-Powerline sub-system. Implementation began in 2014 with the former OPA issuing a letter supporting this project so that it could be brought into service in time to address urgent needs.

³ Conservation First policy:

<http://www.energy.gov.on.ca/en/conservation-first/http://www.energy.gov.on.ca/en/conservation-first/>

⁴ The provincial targets are for energy and have to be converted to capacity to calculate impact on peak demand by conservation.

3. Connect existing 115 kV Circuits B12/13 to B8W

To meet the remaining supply capacity need in the near term, the Working Group recommended the installation of three (3) 115 kV breakers to connect the existing circuits B12/13 from Hamilton to B8W from Woodstock. The budgetary estimate for this project is \$12-15 million with an in-service date of 2017. These switching facilities are expected to provide additional capacity of 40 MW to the Brant-Powerline sub-system after the addition of the capacitor banks at Powerline MTS.

4. Demand response Pilot Program for Brant

A pilot demand response (“DR”) program will be considered by the IESO in order to identify costs and determine feasibility and potential of DR to meet supply capacity needs in the Area. If DR proves to be feasible and economic, it could play an important role in long-term planning for the Area.

2.2 Near- and Medium-Term Actions in Support of Long-Term Plan (2024 through 2033)

The recommended near- and medium-term solutions are expected to satisfy the forecast demand growth for the expected-growth scenario until the end of the study period. In the long term, the Brant Area electricity system’s ability to supply load will be constrained if additional industrial loads arise in the Area or higher demand growth occurs. Thus, the Working Group believes it is prudent to plan to meet a higher-demand scenario for the longer term. This will provide a capacity margin to supply emerging needs, and allow flexibility and time to plan for the next round of growth should a supply gap materialize.

A number of alternatives are possible to meet the Area’s longer-term needs under in the high-demand growth scenario, including combinations of conservation, local generation, “wires” (transmission and distribution) and other emerging technologies. While specific solutions do not need to be committed today, it is prudent to begin work now in order to gather information, monitor developments, engage the community, and develop alternatives to meet the needs and to support decision-making in the next iteration of the IRRP. The longer-term plan sets out the near-term actions required to ensure that options remain available to address future needs if and when they arise. Long-term options will be reviewed in subsequent Burlington-Nanticoke regional planning studies.

Recommended Actions

1. Monitor load growth and conservation achievement and distributed generation performance

On an annual basis, the IESO will coordinate a review of conservation achievement, the uptake of provincial DG projects, and actual demand growth in the Brant Area. This information will be used to track the expected timing of longer-term needs to determine when a decision on the long-term plan is required. Information on conservation and DG performance will also provide useful feedback into the ongoing development of these options as potential long-term solutions. Additionally, the IESO will also monitor results and the incorporation of lessons learned from the DR pilot if it is implemented.

2. Undertake community engagement

Broad community and public engagement is essential to development of a long-term plan. As no long-term needs have been identified for the Brant Area, there is no requirement at this time for engagement on long-term options.

A Local Advisory Committee (“LAC”) may be established for the broader Burlington to Nanticoke region once the IRRP process for the one remaining area in the Burlington to Nanticoke region has been completed. A LAC’s purpose is to provide input and advice on regional plans and the engagement of those plans for an area or region. It is expected that a LAC will consist of community representatives and stakeholders. Advice from the LAC will be incorporated in developing engagement plans for the Area.

3. Continue ongoing work to develop transmission/generation options

The Working Group will continue to work together to evaluate the transmission and generation alternatives to meet the potential long-term needs.

3. Development of the IRRP

3.1 The Regional Planning Process

In Ontario, planning to meet the electricity needs of customers at a regional level is done through regional planning. Regional planning assesses the interrelated needs of a region - defined by common electricity supply infrastructure over the near, medium and long term, and develops a plan to ensure cost-effective, reliable, electricity supply. Regional plans consider the existing electricity infrastructure in an area, forecast growth and customer reliability, evaluate options for addressing needs, and recommend actions.

Regional planning has been conducted on an as needed basis in Ontario for many years. Most recently, the former Ontario Power Authority (“OPA”) carried out regional planning activities to address regional electricity supply needs. The OPA conducted joint regional planning studies with distributors, transmitters, the IESO and other stakeholders in regions where a need for coordinated regional planning had been identified.

In 2012, the Ontario Energy Board convened the Planning Process Working Group (“PPWG”) to develop a more structured, transparent, and systematic regional planning process. This group was composed of industry stakeholders including electricity agencies, utilities, and stakeholders. In May 2013, the PPWG released the Working Group Report to the Board, setting out the new regional planning process. Twenty-one electricity planning regions in the province were identified in the Working Group Report and a phased schedule for completion was outlined. The Board endorsed the Working Group Report and formalized the process timelines through changes to the Transmission System Code and Distribution System Code in August 2013, as well as through changes to the OPA’s licence in October 2013. The OPA license changes required it to lead a number of aspects of regional planning, including the completion of comprehensive IRRPs. Following the merger of the IESO and the OPA on January 1, 2015, the regional planning responsibilities identified in the OPA’s licence were transferred to the IESO.

The regional planning process begins with a Needs Screening process performed by the transmitter, which determines whether there are needs requiring regional coordination. If regional planning is required, the IESO then conducts a scoping assessment to determine whether a comprehensive IRRP is required, which considers conservation, generation, transmission, and distribution solutions, or whether a straightforward “wires” solution is the

only option. If the latter applies, then a transmission and distribution focused Regional Infrastructure Plan (“RIP”) is required. The Scoping Assessment process also identifies any sub-regions that require assessment. There may also be regions where infrastructure investments do not require regional coordination and can be planned directly by the distributor and transmitter, outside of the regional planning process. At the conclusion of the Scoping Assessment, the IESO produces a report that includes the results of the Needs Screening process – identifying whether an IRRP, RIP or no regional coordination is required - and a preliminary Terms of Reference. If an IRRP is the identified outcome, then the IESO is required to complete the IRRP within 18 months. If a RIP is required, the transmitter takes the lead and has six months to complete it. Both RIPs and IRRPs are to be updated at least every five years.

The final IRRPs and RIPs are to be posted on the IESO and relevant transmitter websites, and can be used as supporting evidence in a rate hearing or leave to construct application for specific infrastructure investments. These documents may also be used by municipalities for planning purposes and by other parties to better understand local electricity growth and infrastructure requirements.

Regional planning, as shown in Figure 3-1, is just one form of electricity planning that is undertaken in Ontario. There are three types of electricity planning in Ontario:

- Bulk system planning
- Regional system planning
- Distribution system planning

Figure 3-1: Levels of Electricity System Planning

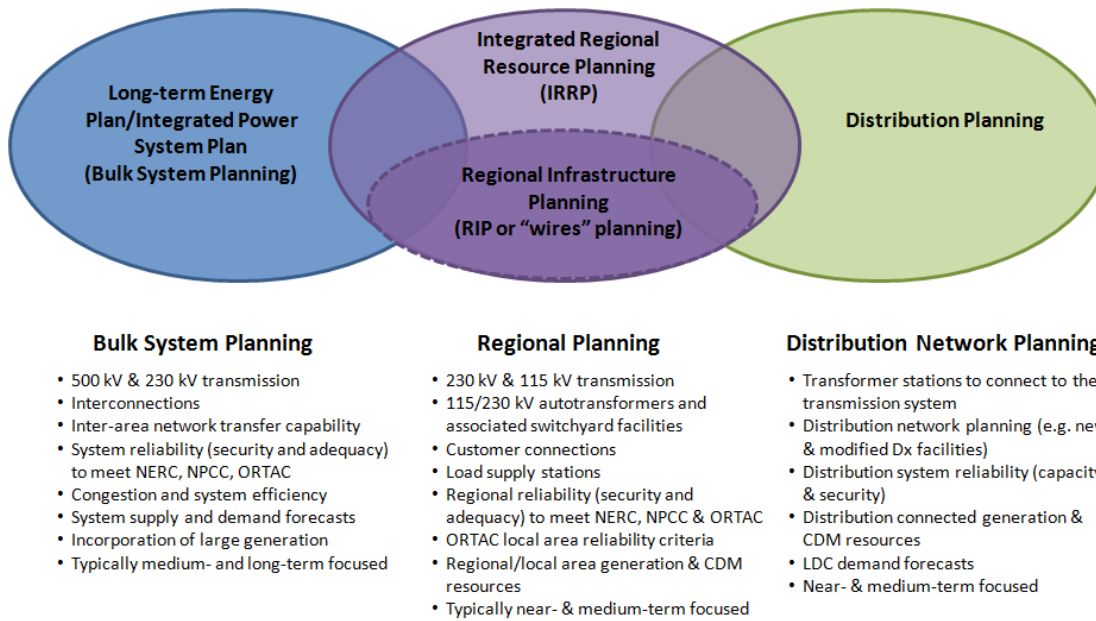

Planning at the bulk system level typically considers the 230 kV and 500 kV network. It is typically carried out by the IESO and considers the major transmission facilities and assesses the resources needed to adequately supply the province. Distribution planning, which is carried out by local distribution companies, looks at specific investments on the low voltage, distribution system.

Regional planning can overlap with bulk system planning. For example, overlap can occur at interface points where regional resource options may also address a bulk system issue. Similarly, regional planning can overlap with the distribution planning of LDCs. An example of this is when a distribution solution addresses the needs of the broader local area or region. Therefore, to ensure efficiency and cost effectiveness, it is important for regional planning to be coordinated with both bulk and distribution system planning.

By recognizing the linkages with bulk and distribution system planning, and coordinating multiple needs identified within a given region over the long term, the regional planning process provides an integrated assessment of needs. Regional planning aligns near- and long-term solutions and allows specific investments recommended in the plan to be understood as part of a larger context. Furthermore, regional planning optimizes ratepayer interests by avoiding piecemeal planning and asset duplication, and allows Ontario ratepayers' interests to be represented along with the interests of LDC ratepayers. Where IRRPs are undertaken, they

allow an evaluation of the multiple options available to meet needs, including conservation, generation, and “wires” solutions. Regional plans also provide greater transparency through engagement in the planning process, and by making plans available to the public.

3.2 The IESO’s Approach to Regional Planning

IRRP’s assess electricity system needs for a region over a 20-year period. The 20-year outlook anticipates long-term trends so that near-term actions are developed within the context of a longer-term view. This enables coordination and consistency with the long-term plan, rather than simply reacting to immediate needs.

In developing an IRRP, a different approach is taken to developing the plan for the first 10 years of the plan—the near- and medium-term—than for the longer-term period of 10-20 years. The plan for the first 10 years is developed based on best available information on demand, conservation, and other local developments. Given the long lead time to develop electricity infrastructure, near-term electricity needs require prompt action to enable the specified solutions in a timely manner. By contrast, the long-term plan is characterized by greater forecast uncertainty and longer development lead time; as such solutions do not need to be committed to immediately. Given the potential for changing conditions and technological development, the IRRP for the long term is more directional, focusing on developing and maintaining the viability of options for the future, and continuing to monitor demand forecast scenarios.

In developing an IRRP, the IESO and regional working group (see below) carry out a number of steps. These steps include electricity demand forecasts; technical studies to determine electricity needs and the timing of these needs; the development of potential options; and, a recommended plan including actions for the near and long term. Throughout this process, engagement is carried out with stakeholders and First Nations and Métis communities and stakeholders. The steps of an IRRP are illustrated in Figure 3-2 below.

The IRRP report documents the inputs, findings and recommendations developed through the process described above, and provides recommended actions for the various entities responsible for plan implementation. Where “wires” solutions are included in the plan recommendations, the completion of the IRRP report is the trigger for the transmitter to initiate an RIP process to develop those options. Other actions may involve: development of

conservation, local generation, or other solutions; community engagement; or information gathering to support future iterations of the regional planning process in the region.

Figure 3-2: Steps in the IRRP Process

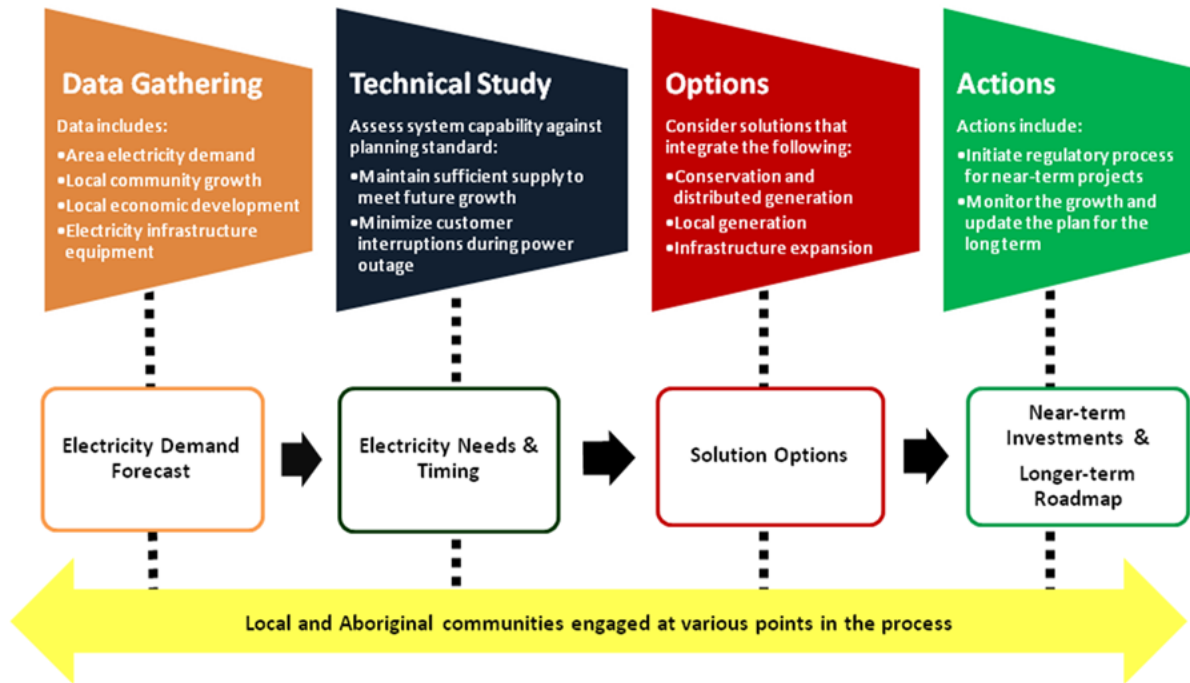

3.3 Brant Area Working Group and IRRP Development

The Brant IRRP is a “transitional” IRRP in that it began prior to formalization of OEB’s regional planning process and some of the study was conducted before the new process and its requirements were known. While much of the work completed in the early days of the study is consistent with the new process, certain aspects of the development of the IRRP have been refined, and the underlying data and assumptions, such as demand forecasts, have been updated to reflect changes since the study began.

In 2013, the Working Group was formed to assess the supply capacity for Brant Area. The Working Group developed a Terms of Reference for the study,⁵ gathered data, identified near- to long-term needs in the Area, and recommended the near- and medium-term actions included in this IRRP.

⁵ Brant IRRP Terms of Reference:
<http://powerauthority.on.ca/sites/default/files/planning/Brant-Terms-of-Reference.pdf>

4. Background and Study Scope

This report presents an IRRP for the Brant Area over a 20-year period from 2014 to 2033. The Brant Area is a sub-region within the Burlington/Nanticoke region.

The geographic scope of the Brant IRRP includes the County of Brant and the City of Brantford. The electricity supply to the study Area is provided by three step-down stations: Brant TS, Powerline MTS and Brantford TS, as shown in Figure 4-1.

Figure 4-1: Brant Area and Vicinity

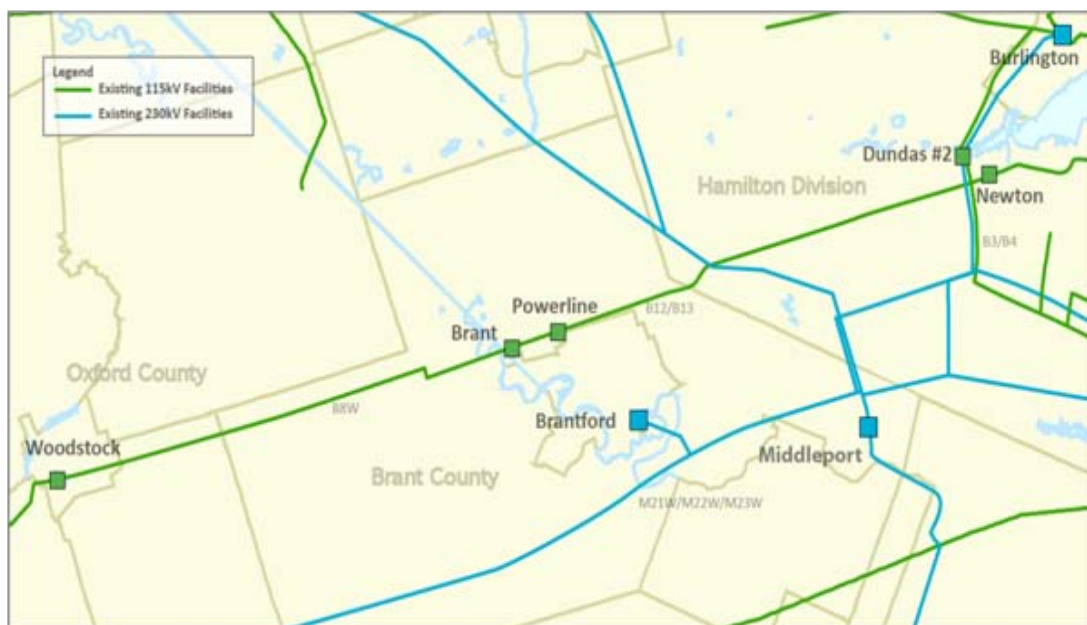

Brant TS and Powerline MTS are connected to the double-circuit 115 kV transmission line, B12/13⁶ originating from Burlington TS. These stations are also backed up in emergencies by the 115 kV line B8W from Woodstock. Under normal operation, the B8W circuit is not connected to the Brant-Powerline sub-system circuits B12/13. The Brantford TS is supplied at 230 kV from the double-circuit transmission line M32/33W between Middleport TS (Hamilton) and Buchanan TS (London). The coincident peak demand of the three stations in summer 2014

⁶ Circuits B12/13 also supply two other DESN stations, Dundas #2 TS and Newton TS in the Hamilton area serving customers of Horizon Utilities Corporation and Hydro One Distribution. As Dundas #2 TS and Newton TS are not directly impacted by the supply issues associated with the Brant Area in this study, a detailed assessment of these two stations is covered in the broader region needs screening of Burlington-Nanticoke.

was approximately 250 MW. Distribution service to customers in the Area is provided by Brant County Power Inc., Brantford Power Inc. and Hydro One Distribution.

For the purposes of this IRRP, the term “Brant Area” is used to more precisely define the Area supplied by the following transformer stations: Brant TS, Powerline MTS and Brantford TS.

For the purposes of this IRRP, the transmission system in the Brant Area is further divided into two sub-systems:

1. The Brant Powerline sub-system: customers supplied from Brant TS and Powerline MTS via the B12/B13 115 kV transmission line; and
2. The Brantford TS sub-system: customers supplied from Brantford TS via the 230 kV transmission line M32W/M33W.

While there is some emergency transfer capability between the two Brant Area sub-systems, they are normally operated independently.

These two sub-systems are shown in Figure 4-2 below.

Figure 4-2: Brant Area Sub-systems

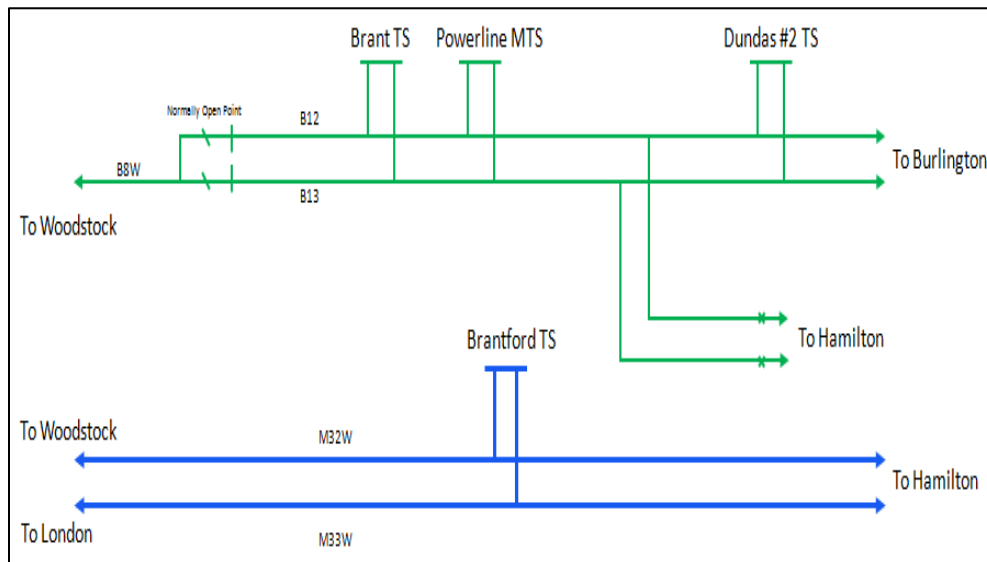

5. Demand Forecast

5.1 Historical Demand

Actual peak electricity demand in the Brant Area has increased moderately from 242 MW in 2008 to 259 MW in 2013, with a modest drop to 250 MW in 2014. This represents a nominal growth rate of 1.9 %, as shown in Figure 5-1. The historical peak demand reflects the weather experienced at the time of the system’s coincident peak, and includes the impacts of conservation and DG.

Figure 5-1: Brant Area Historical Electricity Demand

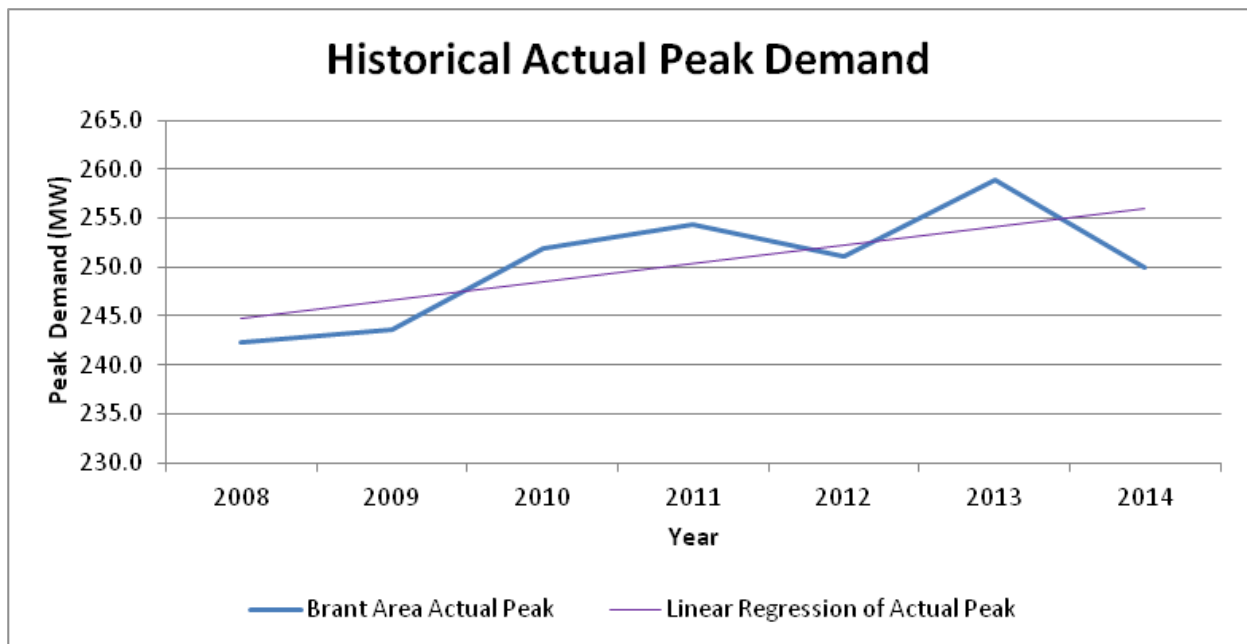

5.2 Demand Forecast Methodology

Regional electricity needs are driven by the limits of the infrastructure supplying an area, which is sized to meet peak demand requirements of that area. Therefore, regional planning typically focuses on growth in regional-coincident peak demand. Energy adequacy is usually not a concern of regional planning, as the region can generally draw upon energy available from the provincial electricity grid, with energy adequacy for the province being planned through a separate process.

The near- and medium-term aspects of a forecast are closely linked to the historical growth experienced in an area and is usually based on loads expected to be in-service within a few years of growth being planned. Unmet needs forecast to arise during this time frame typically require solutions to be developed and implemented during the current planning cycle. The long-term forecast is typically used to identify emerging issues and to set longer-term priorities, with the goal of ensuring near- and medium-term actions will not be stranded or somehow limited in value by the most likely long-term outcomes.

After taking into consideration the combined impacts of conservation and DG, a 20-year planning forecast was produced based on the LDCs' gross demand forecasts and reflecting the 2013 LTEP growth assumptions - this is the expected-growth forecast. Additionally, a second net demand forecast was prepared for the longer term to account for added planning uncertainty, based on the provincial Places to Grow Act - this is referred to as the higher-growth forecast.

5.2.1 Near- and Medium-Term (2014 through 2023)

For the near and medium term, a regional peak demand forecast was developed as shown in Figure 5-2. Gross demand forecasts, assuming normal-year weather conditions, were provided by the LDCs. The LDCs' forecasts are based on growth projections included in regional and municipal plans, which in turn reflect the province's Places to Grow policy. These forecasts were then modified to reflect the peak demand impacts of provincial conservation targets and DG contracted through provincial programs such as FIT and microFIT, and adjusted to reflect extreme weather conditions, to produce a planning forecast. The planning forecast was then used to assess any growth-related electricity needs in the region.

Using a planning forecast that is net of provincial conservation targets provides consistency with the province's Conservation First policy by reducing demand requirements before assessing any growth-related needs. The planning forecast assumes that these conservation targets will be met and that the targets, which are energy-based, will produce the expected local peak demand impacts. Therefore, an important aspect of plan implementation will be monitoring the actual peak demand impacts of conservation programs delivered by the local LDCs.

Figure 5-2: Development of Demand Forecasts

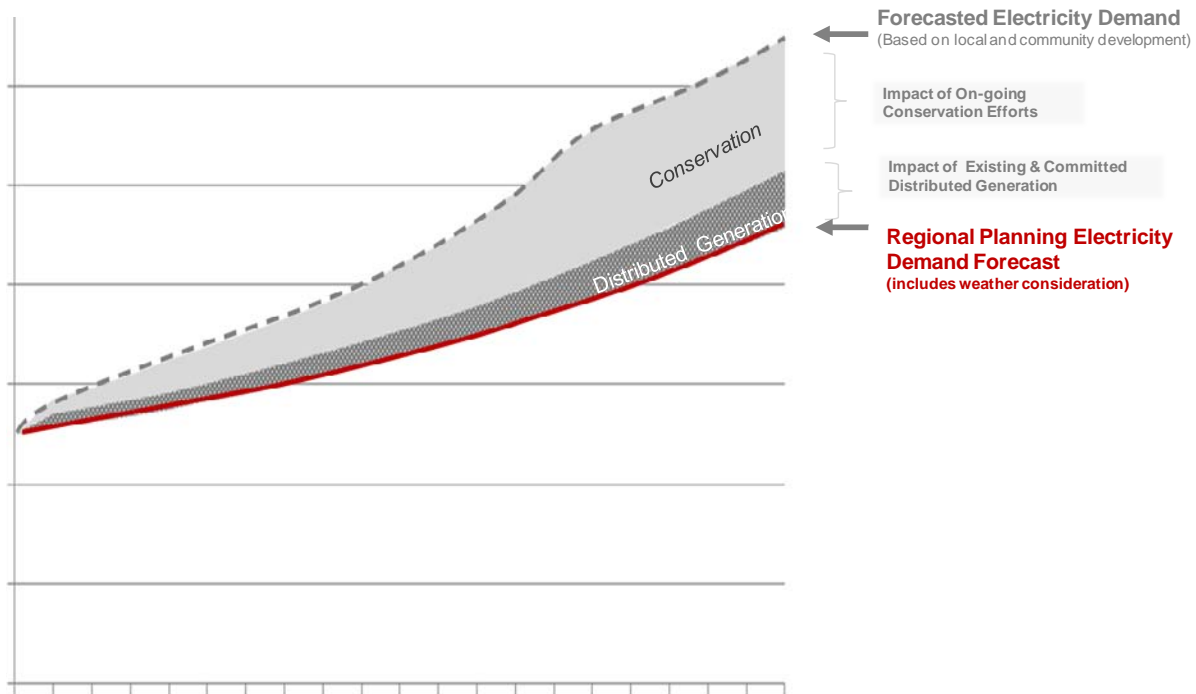

5.2.2 Longer Demand Forecast (2024 through 2033)

For the longer-term outlook, two demand forecast scenarios were developed to reflect the inherent uncertainty associated with forecasting this far in the future.

1. **“Expected Growth”**: This scenario was developed consistent with the growth assumptions embodied in the government’s provincial energy plan. As with the near and medium-term (0-10 years) forecast, the provincial conservation targets up to 2032 are deducted from the gross demand projections to produce a planning forecast net of conservation.
2. **“Higher Growth”**: This scenario was developed to reflect continued development in Brant Area consistent with the projections associated with the province’s *Places to Grow Act, 2005*. This higher-growth forecast scenario is consistent with the growth assumptions associated with the long-term municipal plan projections. As with the near- and medium-term forecasts, the provincial conservation targets up to 2032 are deducted from the gross demand projections to produce a planning forecast net of conservation.

Additional details related to the development of the demand forecasts are provided in Appendix A.

5.3 Gross Demand Forecast

The gross demand forecast for the Brant Area was developed by the Area LDCs based on historical growth rates. The forecast population is based on the Ministry of Finance's Spring 2013⁷ population projection for the Brant Census Division, which includes the City of Brantford and Brant County. The Brant Census Division forecasts an average annual population growth rate of 0.9% from 2012-2031.

Area LDC forecasts are based on historical growth rates, supported by Municipal and Regional Official Plans as a primary source for input data. Other common considerations included known connection applications, and typical electrical demand intensity for similar customer types.

Additional background on the methodology used by each LDC to prepare their gross demand forecasts are available in Appendix A.

5.4 Conservation Assumed in the Forecast

Conservation plays a key role in maximizing the useful life of existing infrastructure, and maintaining reliable supply. Conservation is achieved through a mix of program-related activities, including behavioral changes by customers and mandated efficiencies from building codes and equipment standards ("C&S"). These approaches complement each other to maximize conservation results. The conservation savings forecast for Brant Area are applied to the gross peak demand forecast.

In December 2013 the Ministry of Energy released a revised Long-Term Energy Plan ("LTEP"), which outlined a provincial conservation target of 30 TWh of energy savings by 2032. In order to represent the effect of these targets within regional planning, the IESO developed an annual forecast for peak demand savings resulting from the provincial energy savings target, which was then expressed as a percentage of demand in each year. These percentages were applied to the LDCs' demand forecasts to develop an estimate of the peak demand impacts from the provincial targets in the Brant Area.

⁷ Ministry of Finance Spring 2013 population projection
<http://www.fin.gov.on.ca/en/economy/demographics/projections/table6.html>

It is assumed existing DR already in the base year will continue. Savings from potential future DR resources are not included in the forecast and are instead considered as possible solutions to identified needs.

5.5 Distributed Generation Assumed in the Forecast

In addition to conservation resources, DG in the Brant Area is also applied to offset peak demand requirements. Distributed generation resource development in Ontario has been encouraged by the *Green Energy Act, 2009* and associated procurements such as the Feed-in Tariff (“FIT”) program. These procurements have increased the significance of DG in Ontario. This generation, while intermittent in nature, contributes to meeting the electricity demands of the province. These procurements take into consideration the system need for generation as well as cost.

One aspect related to DG that should be noted is that DG resources, such as intermittent renewable generation resources like wind and solar, are not always available at the time of system peak. Therefore, the assumed effective capacity of these facilities (approximately 20 MW), not the full installed capacity, is applied to the Brant Area peak demand.⁸ The location, contract capacity, and effective contribution of these resources in the Brant Area can be found in Appendix A.

⁸ Effective capacity is the portion of installed capacity that contributes at the time of system peak.

5.6 Planning Forecasts

5.6.1 Total Demand Forecast in Brant Area

Figure 5-3: Brant Area Total Demand Forecast

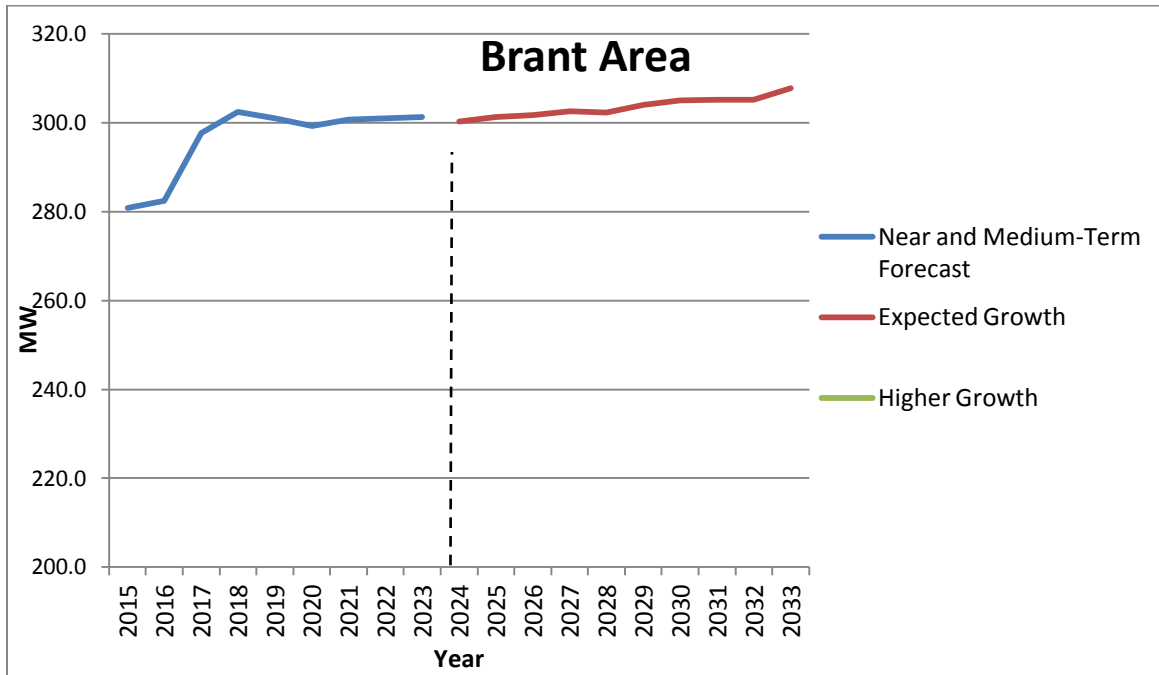

5.6.1.1 Near- and Medium-Term (2014 through 2023)

The near- and medium-term aspects of a forecast are closely linked to the historical growth experienced in an area and are usually based on loads expected to be in-service within a few years or growth being planned.

The summer peak demand planning forecast of the Brant Area is shown in Figure 5-3. There is a noticeable step increase in peak demand from the year 2015 to 2018. This is based on customers requesting connection over the next three years. Approximately 37 MW of industrial demand was added to the demand forecast in 2014, which is roughly 15% of the total Area demand. These types of loads often arise on short notice and in large blocks as is evidenced from the in-service dates of 2015 through 2018 and the step changes noticeable in the graph. For example, a forging expansion project will need additional 16 MW supply capacity by 2016.

Table 5-1 below shows the size of the large industrial loads which have been considered in the demand forecast based on LDCs information.

Table 5-1: Near-Term Industrial Load

Proposed Connection Station	LDCs	Estimated Size (MW)
Brantford TS	Brantford Power Inc.	16
Brant TS	Brantford Power Inc.	6
Powerline MTS	Brant County Power Inc.	8
Brantford TS	Brant County Power Inc.	4
Brant TS	Brant County Power Inc.	3
Total Load Added		37

The type of block industrial load that has been considered in the near- to medium-term forecast is difficult to forecast for the long term. As seen in Table 5-1, the loads are not concentrated at one station or within one LDC and these types of block loads can also appear with short notice. Consequently, industrial growth incremental to the loads indicated in Table 5-1 were not forecast as part of the medium-term forecast.

5.6.2 Long-Term (2024 through 2033)

For the longer-term outlook, two demand forecast scenarios were developed to reflect the inherent uncertainty associated with forecasting this far in the future.

The “expected-growth scenario” was developed consistent with the growth assumptions embodied in the government’s 2013 LTEP. This scenario was a continuation of the forecast used for the near- and medium-term. The expected-growth scenario represents a future with lower electricity demand growth, due to higher electricity prices, increased electricity conservation, and lower energy intensity of the economy. The long-term Area forecast under the expected-growth scenario grows 27 MW from 281 MW to 308 MW. This includes the reduction in demand of approximately 49 MW from conservation, and approximately 18 MW from DG.

Taking into account the type of load growth the Brant Area has experienced (i.e., fast developing, large block loads), the Working Group examined an additional scenario to consider the possible impact of higher growth on the Area’s needs. A higher-growth scenario was developed to reflect continued development in the Brant Area consistent with the projections associated with the province’s Places to Grow policy. This forecast scenario is also consistent

with growth assumptions associated with the long-term municipal plan projections for the Brant Area.

The higher-growth forecast assumes a total of 57 MW of new savings from conservation targets across the Brant Area over the next 20 years.

5.6.3 Sub-system Forecasts

For the Brant-Powerline sub-system, the forecast demand under the expected-growth scenario grows from 140 MW to 158 MW from 2015 to 2033. This includes the reduction of approximately 25 MW from conservation, and approximately 9 MW from DG, with approximately 13 MW of demand reduction through conservation expected in the 2024-2033 timeframe. For the higher-growth scenario, the forecast grows from 157 MW in 2024 to 177 MW in 2033.

Figure 5-4: Brant TS and Powerline MTS Forecast

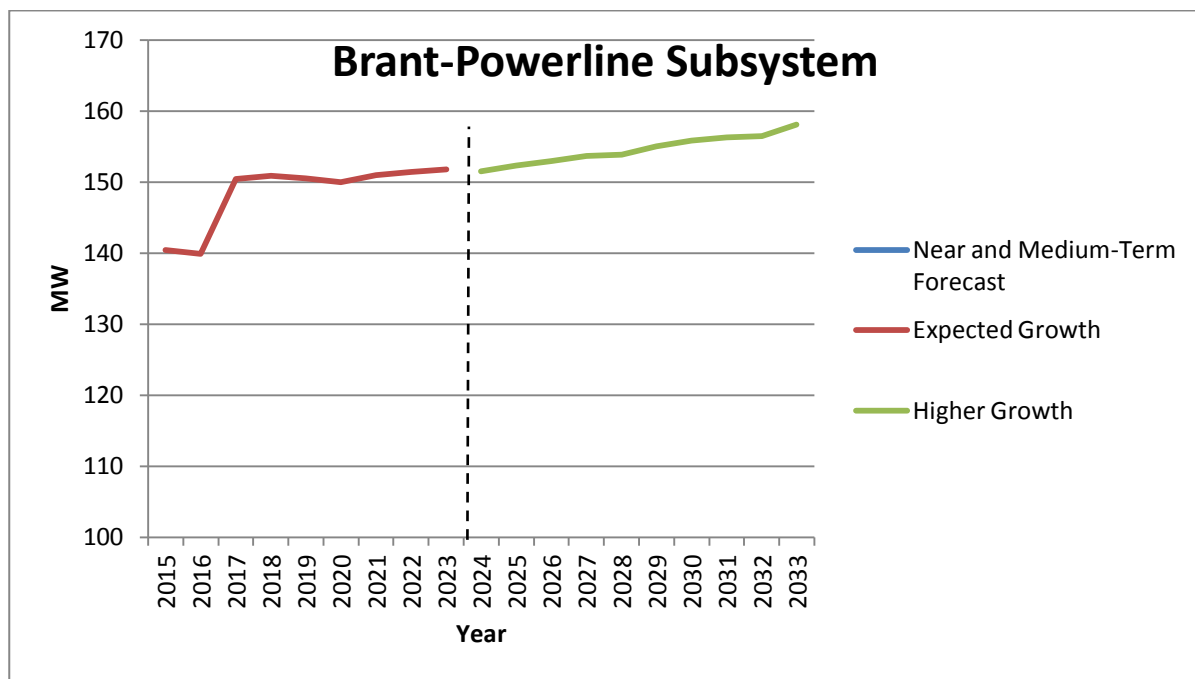

For the Brantford TS pocket, the forecast demand under the expected-growth scenario grows from 146 MW to 156 MW from 2015 to 2033. This includes the reduction of approximately 25 MW from conservation, and approximately 10 MW from DG. For the higher-growth scenario, the forecast grows from 165 MW in 2024 to 182 MW in 2033.

Figure 5-5: Brantford TS Planning Forecast

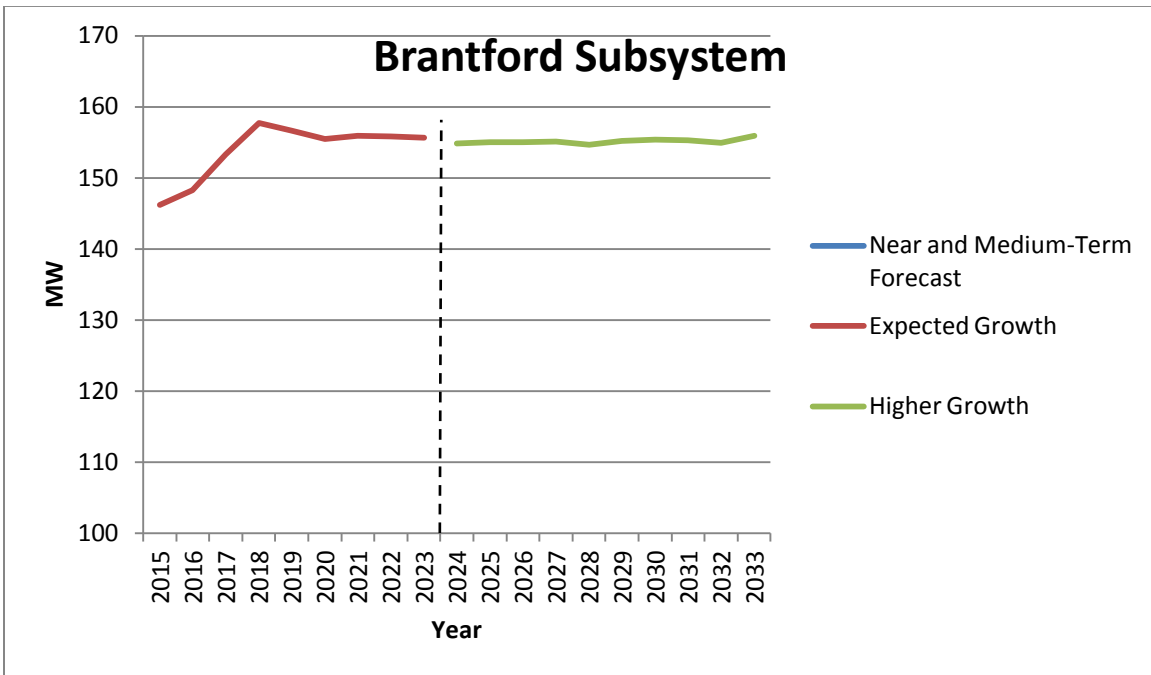

6. Electricity System Needs

Based on the demand forecasts, system capability, and the Ontario Resource and Transmission Assessment Criteria (“ORTAC”)⁹ criteria, the Working Group identified electricity needs in the near-to-medium term (0-10 years), and in the long term (11-20 years). This section describes the identified needs for the Brant Area.

6.1 Needs Assessment Methodology

Provincial assessment criteria and standards (ORTAC) were applied to assess the capability of the existing electricity system to supply forecast electricity demand growth in the Brant Area over the next 20 years (refer to Section 5). These criteria were applied to assess three broad categories of needs.

- Supply capacity requirements were assessed using PSS/E, a power flow simulation tool, to analyze the capability of the existing system, including transmission and local generation infrastructure, to supply load growth. Technical study is provided in Appendix B.
- ORTAC standards were applied to identify areas with needs to address the impacts of potential major supply interruptions. The amount of customer load supplied from specific circuits before and after potential contingencies, and the capability to restore interrupted loads following a contingency, either through transmission system switching or transfers on the distribution system, were assessed in accordance with these criteria.
- Step-down station capacity needs were identified by comparing forecast demand growth to the 10-day Limited Time Rating (“LTR”), or thermal capacity, of the existing stations in the Area, to determine the net incremental requirement for transformation capacity in the Area.

6.2 Ontario Resource and Transmission Assessment Criteria

The ORTAC the provincial standard for assessing the reliability of the transmission system, were applied to assess supply capacity and reliability needs.

The ORTAC includes criteria related to assessment of the bulk transmission system, as well as the assessment of local or regional reliability requirements. The latter criteria are relevant to this study and guided the technical studies performed in assessing the electricity system needs

⁹ http://www.ieso.ca/imoweb/pubs/marketadmin/imo_req_0041_transmissionassessmentcriteria.pdf

in Brant Area. The needs can be broadly categorized as addressing two distinct aspects of reliability: (1) providing supply capacity, and (2) limiting the impact of supply interruptions. Further details on the application of these criteria are provided in Appendix B.

6.3 Near- and Medium-Term Needs

Near- to medium-term needs often require action immediately to ensure that a solution is in place to address the need by the time it arises.

6.3.1 Need for Additional Supply Capacity

Brant-Powerline Sub-system

Today, the B12/B13 115 kV transmission line serving the Brant-Powerline sub-system has a LMC of approximately 104 MW. This limit is based on the violation of the voltage criteria following the loss of one of the B12/13 circuits.

As shown in Figure 6-1 below, peak demand for this sub-system has already exceeded the LMC, and is forecast to continue to exceed this limit throughout the study period.

Figure 6-1: Historical and Forecast Electricity Demand and Supply Capability in the Brant-Powerline Sub-system

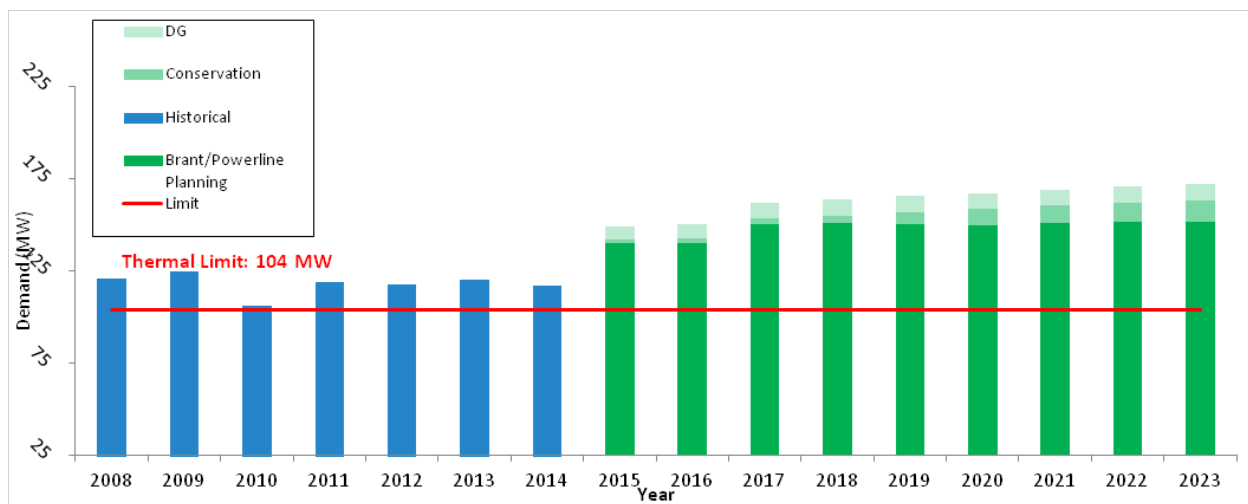

Based on the forecast, additional capacity is required to meet current and future electricity demand in the Brant-Powerline sub-system. Until additional capacity is provided, operating measures such as temporary load transfers or interruption of load following a single

contingency will be required. The existing system does not meet the ORTAC criteria for supply capacity in the near and medium term.

Brantford TS Sub-system

The Brantford TS sub-system meets the ORTAC criteria for supply capacity for the reference forecast throughout the study period.

6.3.2 Load Restoration Needs

Brant -Powerline Sub-system

Brant TS and Powerline MTS sub-system meets the ORTAC restoration criteria until the end of the study period.

Brantford TS Sub-system

The Brantford TS sub-system meets the ORTAC restoration criteria until the end of the study period.

6.3.3 Conclusion Near- and Medium-Term Electricity Needs

The Brant-Powerline sub-system has already exceeded the LMC of the supply circuits and there is further significant step load growth identified by the LDCs forecast over the next five years. Therefore, an urgent need has been identified to provide additional capacity to the Brant-Powerline 115 kV sub-system.

6.4 Long-Term Needs

To assess needs in the long term, two demand forecast scenarios were considered: expected-growth and high-growth (see Section 5.2). As described in Section 7, the near- and medium-term plan is expected to meet the needs of the Area until the end of the study period.

However, if Area demand is consistent with the higher-growth scenario, additional electricity capacity needs may arise before the end of the study period. Thus, the analysis in this section is to address a scenario where there is a potential need for additional long-term Area supply.

Higher Growth Scenario

The Brant Area peak demand is forecast to grow to 352 MW by 2033 under the higher-growth scenario. At the sub-system level, the Brant-Powerline sub-system is forecast to grow to 177 MW and the Brantford TS sub-system to 182 MW under this scenario by 2033.

Table 6-1: Capacity Gap in 2033 under Higher-Growth Scenario

	Limit after Near- and Medium-Term Solutions (MW)	Higher Growth Forecast demand in 2033 (MW)	Higher Growth Capacity Gap in 2033 (MW)
Brant-Powerline sub-system	165	177	12
Brantford TS sub-system	178	182	4
Brant Area	343	352	9

In the long term, the Brant Area electricity system's ability to supply load will be constrained if additional industrial block loads arise in the Area, or higher demand growth is experienced consistent with the higher-growth scenario (Section 5.6.2). Supply constraints will leave the LDCs unable to connect new customers without additional supply in the Area. Consequently, the Working Group agreed to develop a strategic plan to consider higher demand growth based on the Places to Grow assumptions or additional industrial block loads.

7. Near- and Medium-Term Plan

The plan to address the near- and medium-term electricity needs of the Brant Area consists of specific actions and projects for immediate implementation, reflecting the urgency of the needs and the lead time for developing solutions (refer to Section 6.3).

This section describes the alternatives considered in developing the near-term plan for the Brant Area and provides details and rationale for the recommended plan.

7.1 Alternatives for Meeting Near- and Medium-Term Needs

In developing the near- and medium-term plan, the Working Group considered a range of integrated options. Considerations in assessing alternatives included maximizing use of existing infrastructure, provincial electricity policy, feasibility, cost, and consistency with longer-term needs in the Brant Area.

7.1.1 Conservation

Conservation was considered as the first alternative to meet the electricity needs through the development of a planning forecast that includes the peak-demand effects of the provincial conservation targets,¹⁰ along with contracted DG (see Sections 5.4 and 5.5). These conservation resources account for approximately 30 MW, or approximately 40% of the forecast demand growth during the first 10 years of the study period (through 2024).

Additional conservation beyond the targeted amounts included in the demand forecast may assist in meeting growth-related needs, such as the need to provide additional LMC in the Brant-Powerline sub-system. To meet these needs with conservation, an additional 50 MW of peak-demand reductions (i.e., 45% of sub-system load), incremental to the forecast of 12 MW from the LTEP conservation target would be required by 2023. This 50 MW plus the 12 MW targeted conservation amounts to approximately 45% of sub-system load. Given the immediate need and magnitude of the needs relative to the LTEP conservation target, the Working Group agreed that additional conservation beyond the targeted amounts is not a feasible option to meet the needs of the Area. However, efforts in the near- and medium-term should be focused on ensuring that the provincial conservation targets are met and monitoring the associated

¹⁰ The provincial targets are for energy and have to be converted to capacity to calculate impact on peak demand by conservation

peak-demand savings that were assumed for the Brant Area. Therefore, conservation efforts to meet this goal are included as a recommendation in the near-term plan.

A provincial DR pilot is expected to roll out in the 2015-2016 time period. The Working Group believes it is prudent to consider this pilot program for the Brant Area to investigate opportunities, costs and feasibility in order to better understand its potential to address the Area's long-term supply capacity needs. A pilot can provide insights into the existence of willing DR participants in the Area. Knowledge and experience gained by way of a pilot will be useful when DR capacity markets are implemented by the IESO in the future and will help to address system as well as regional needs in the Brant Area and other areas of the province. At this time large scale use of DR has not been used as a solution to address local area's needs. Thus, a DR pilot program for the Brant Area could demonstrate its potential to be a technically feasible and cost-effective solution to provide a capacity buffer for the Area and defer larger and more costly infrastructure alternatives.

7.1.2 Local Generation

While in general local generation has the potential to meet both supply capacity and load restoration needs, this alternative was ruled out by the Working Group for meeting the near- to medium-term needs.

For the Brant Area, a natural gas plant for peak supply could meet the capacity needs at a cost of approximately \$700-1000/kW with a 2-3 year in-service lead time.

It is the Working Group's view that local generation is not a cost effective option when compared to the recommended transmission options discussed below. Local generation is also not able to maximize the use of the existing Brant-Powerline sub-system infrastructure.

7.1.3 Transmission

Since the LMC of circuits B12/13 is primarily voltage limited, a number of voltage support options were considered to meet the near- and medium-term capacity needs of the Brant Area.

Capacitor Banks at Powerline MTS

Capacitor banks provide reactive support, boosting the voltage in an area. In doing so, they increase the voltage limit which is the first limiting factor in the 115 kV Brant-Powerline sub-system. The IESO and Hydro One studies have shown that 30 MVAR of reactive support at

Powerline TS can raise the LMC of the Brant-Powerline sub-system to 125 MW from 104 MW, thus increasing the useable capacity in the 115 kV Brant-Powerline sub-system. Capacitor banks also have relatively short 1-2 year in-service lead times. This option would cost approximately \$1.0 million or \$48/kW based on preliminary cost estimates by the LDC's and Hydro One.

Switching Facilities at Brant TS

This option connects the B8W and B12/13 circuits by installing three 115 kV breakers to close the existing normally open points. This option by itself can provide approximately 40 MW of additional supply to the limiting B12/13 circuits. Combined with the capacitor banks option as described above, the LMC of the Brant-Powerline sub-system can be further increased to approximately 165 MW.

It is estimated that the breakers can be in-service by 2017 and the budgetary estimate is \$12-15 million based on Hydro One's preliminary cost estimates or \$300-\$375/kW. Hydro One and LDCs can together develop an implementation plan.

7.1.4 Distribution Options

Load transfers move load from one station to another and are currently used in the Brant Area on a temporary basis to maintain the loading on the 115 kV radial pocket within its LMC during peak demand conditions.

Depending on system conditions, Brantford Power has indicated that it has the ability to transfer up to 10 MW on a temporary, short-term basis from Powerline MTS and/or Brant TS to the Brantford TS. However, due to existing demand and future load growth, Brantford Power does not have the capacity at Brantford TS for permanent load transfers from the 115 kV sub-system. The incremental load at Brant Powerline sub-system in 2015 that is over the current 104 MW limit is expected to be 36 MW; this amount of load would be enough to exceed the limit at the Brantford TS. Therefore, load transfers are not a solution for the Area's capacity needs, as the surplus capacity that exists in the Area will be used up immediately.

7.2 Recommended Near- and Medium-Term Plan

The Brant Area Working Group assessed these alternatives in Section 7.1 as the basis for the following recommendations. Successful implementation of this plan will address the Area's electricity needs until the end of the study period.

To ensure the reliability of the Brant-Powerline sub-system before any permanent solutions are put in place, temporary load transfers will continue to be used in the near and medium term as required by the LDCs to address operational requirements.

Conservation

Meeting the conservation targets is assumed before identifying residual needs for the Area. The Working Group recommends that LDCs' conservation efforts be focused on measures that balance the needs for energy savings to meet the Conservation First targets while maximizing peak-demand reductions. Monitoring of conservation success, including measurement of peak demand savings, will be an important element of the near- and medium-term plan, and will also lay the foundation for the long-term plan by reviewing the performance of specific conservation measures in the Brant Area, and assessing potential in the Area for further conservation efforts.

Capacitor Banks at Powerline MTS

The Working Group recommended the installation of capacitor banks at Powerline MTS to raise the LMC of the circuits to 125 MW. The implementation of the capacitor bank solution was assigned to Hydro One by way of a letter¹¹ from the former OPA in February 2014. The capacitor banks are expected to be in-service for summer 2015 and the implementation is being undertaken by Brantford Power Inc. and Brant County Power Inc.

Switching Facilities at Brant TS

The Working Group recommends utilizing the existing B8W circuit by adding three breakers on circuits B12/13 and B8W. Combined with the capacitor banks, the LMC of the Brant-Powerline sub-system can be further increased to approximately 165 MW. As shown in Figure 7-1, the supply capacity needs under the expected-growth forecast will be addressed by implementing these two stages of transmission reinforcement.

Demand Response

The Working Group has also considered investigating DR opportunities in the Brant Area by way of a DR pilot. The pilot program would be undertaken by the IESO in conjunction with

¹¹ [http://www.hydroone.com/RegionalPlanning/Burlington/Documents/OPA Letter - Burlington Nanticoke - Brant.pdf](http://www.hydroone.com/RegionalPlanning/Burlington/Documents/OPA%20Letter%20-%20Burlington%20Nanticoke%20-%20Brant.pdf)

Area LDCs to investigate opportunities, costs and quantity of DR available in the Brant Area. Knowledge and experience gained by way of a pilot will be useful to provide options for addressing potential future capacity needs under a high-growth scenario.

Figure 7-1: Brant-Powerline Sub-system Planning Forecast and LMC

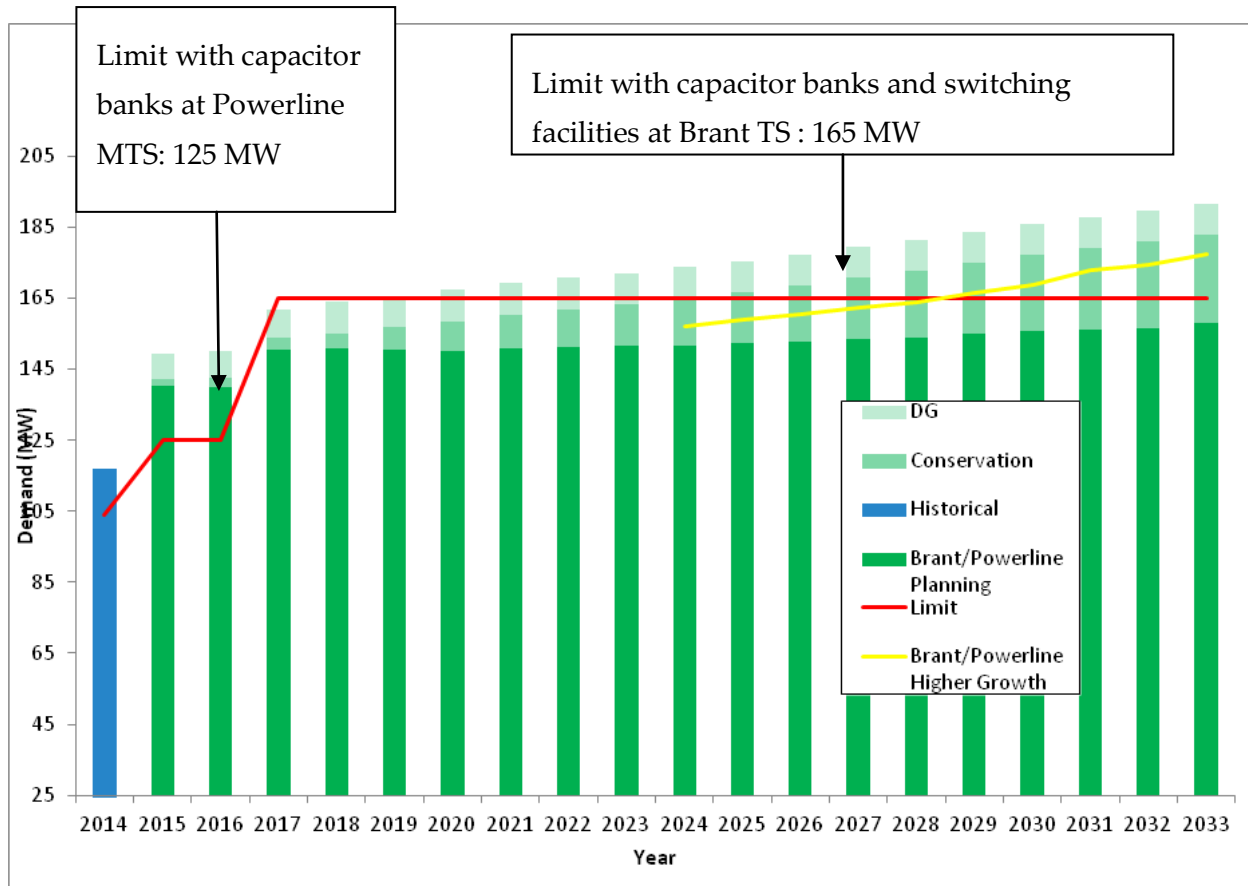

As shown in Figure 7-1, the recommended near- and medium-term solutions meet the needs of the Area until the end of the study period for the expected-growth scenario. These solutions are foundational for any longer-term considerations should electricity demand growth correspond with the higher-growth scenario or the Area experiences greater industrial load growth than is forecast.

7.3 Implementation of Near- and Medium-Term Plan

To ensure that the near-term electricity needs of Brant Area are addressed, it is important that the near- and medium-term plan recommendations be implemented in a timely manner. The specific actions and deliverables associated with the near- and medium-term plan are outlined

in Table 7-1 below, along with their recommended timing, and the parties with lead responsibility for implementation.

Table 7-1: Implementation of Near- and Medium-Term Plan for the Brant Area

Recommendation	Action(s)/Deliverable(s)	Lead Responsibility	Timeframe
1. Implement conservation and DG	Develop CDM plans	LDCs	May 2015
	Implement LDC CDM programs	LDCs	2015-2020
	Conduct Evaluation, Measurement and Verification (EM&V) of programs, including peak-demand impacts, and provide results to Working Group	IESO	annually
	Continue to support provincial DG programs	LDCs/IESO	ongoing
2. Add capacitor banks at Powerline MTS	Design, develop and construct capacitor banks at Powerline MTS	Brantford Power Inc. and Brant County Power Inc.	ongoing and expected to be in-service summer 2015
3. Add switching facilities at Brant TS	Design, develop and construct new switching facilities at Brant TS	Hydro One, Brantford Power Inc. and Brant County Power Inc.	in-service summer 2017
4. Consider DR pilot for the Area	Continue to investigate opportunities for a DR pilot in the Brant Area	IESO	ongoing

8. Long-Term Plan (2024 through 2033)

The approach to developing long-term electricity plans is somewhat different than for near- or medium-term plans. There is inherently greater certainty in assessment of near- and medium-term electricity needs. For these needs, specific projects may need to be committed to ensure they are available to meet the forecast need. For longer-term electricity needs, there is an opportunity to develop and explore a broader set of options, as specific projects typically do not need to be committed urgently. Instead, the focus is on identifying potential need and on exploring alternatives to meet these needs. There is flexibility to assess alternatives that are not in widespread use but which show promise for the future. There is also opportunity to engage with stakeholders and communities to identify alternatives, to set out preliminary actions, and to monitor actual load growth and the underlying drivers. This approach is designed to: maintain flexibility; avoid committing ratepayers to investments before they are needed; provide adequate time to gauge the success and future potential of conservation measures; test out emerging technologies; engage with communities and stakeholders; coordinate with municipal or community energy planning (“MEP/CEP”) activities; to lay the foundation for well-informed decisions in the future; and support decision-making in the next iteration of the IRRP.

An important consideration in developing a long-term plan is recognizing the timeframe within which decisions will need to be committed. This involves integrating the projected timing of needs with the expected in-service lead times when identifying and considering alternatives. The longest lead time among all the possible alternatives is usually associated with new major transmission infrastructure, which typically requires 5-7 years to bring into service (including conducting development work, gaining regulatory and other approvals, construction and commissioning).

Based on the expected timing of the long-term needs in the Brant Area and the 5-7-year lead time for major infrastructure alternatives, the Working Group expects that a decision on the long-term plan will likely be required around 2028. Therefore, it is recommended that demand growth be monitored regularly as part of the implementation of this IRRP and, if necessary, that the IRRP be revisited ahead of the 5-year schedule mandated by the OEB’s regional planning process.

The following sections describe various approaches for meeting the long-term electricity needs of the Brant Area, and lay out recommended actions to develop the longer-term plan, and their implementation.

8.1 Approaches to Meeting Long-Term Needs

In recent years, a number of trends, including technology advances, policy changes supporting DG, greater emphasis on conservation as part of electricity system planning, and increasing community interest and desire for involvement in electricity planning and infrastructure siting, are changing the landscape for regional electricity planning. Traditional, “wires” based approaches to electricity planning, while still technically feasible, may not be the best fit for all communities. New approaches that acknowledge and take advantage of these trends should also be considered.

To facilitate discussions about how a community might plan its future electricity supply, three conceptual approaches for meeting a region’s long-term electricity needs provide a useful framework (see Figure 8-1). Based on regional planning experience across the province over the last 10 years, it is clear that different approaches are preferred in different regions, depending on local electricity needs and opportunities, and the desired level of involvement by the community in planning and developing its electricity infrastructure.

Figure 8-1: Approaches to Meeting Long-Term Needs

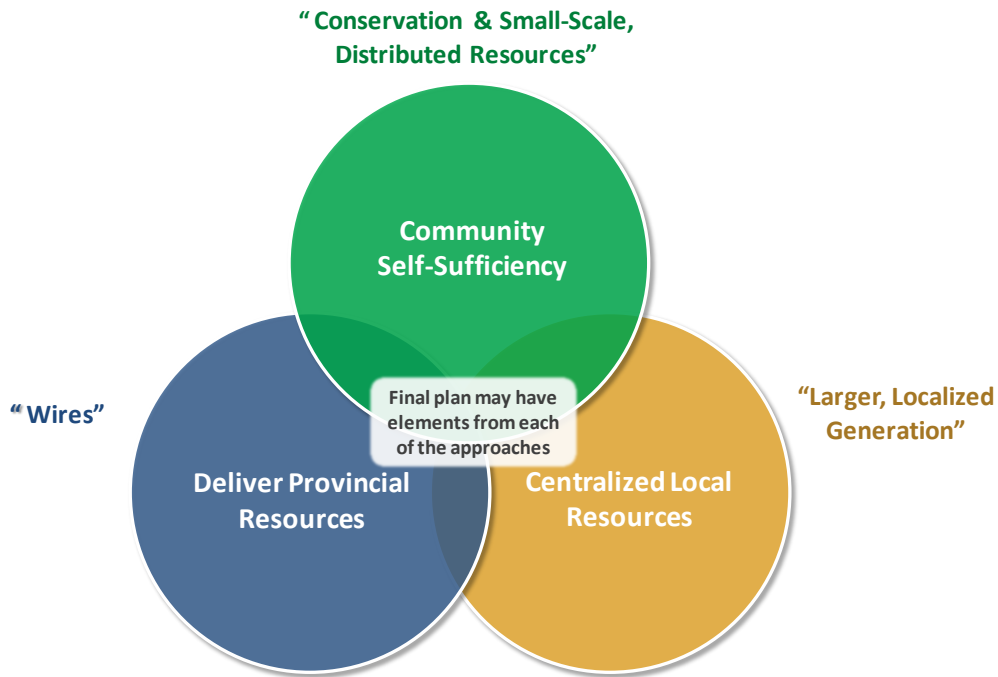

The three approaches are as follows:

- **Delivering provincial resources**, or “wires” planning, is the traditional regional electricity planning approach associated with the development of centralized electric power systems over many decades. This approach involves using transmission and distribution infrastructure to supply a region’s electricity needs, taking power from the provincial electricity system. This model takes advantage of generation that is planned at the provincial level, with generation sources typically located remotely from the region. In this approach, utilities (transmitters and distributors) play a lead role in development.
- The **Centralized local resources** approach involves developing one or a few large, local generation resources to supply a community. While this approach shares the goal of providing supply locally with the community self-sufficiency approach below, the emphasis is on large central-plant facilities rather than smaller, distributed resources.
- The **Community self-sufficiency** approach entails an emphasis on meeting community needs largely with local, distributed resources, which can include: aggressive conservation beyond provincial targets; demand response; distributed generation and storage; smart grid technologies for managing distributed resources; integrated heat/power/process systems; and electric vehicles. While many of these applications are not currently in widespread use to address regional capacity needs, for regions with

long-term needs (i.e., 10-20 years in the future) there is an opportunity to develop and test out these options to provide firm capacity resources at the local level before long-term plan commitment decisions are required. The success of this approach depends on early action to explore potential and develop options, and on the local community taking a lead role. This could be through a MEP/CEP process, or an LDC or other local entity taking initiative to pursue and develop options.

The intent of this framework is to identify which approach is to be emphasized in a particular region. In practice, certain elements of electricity plans will be common to all three approaches, and there will necessarily be some overlap between them. For example, provincially mandated conservation targets will be an element in all regional electricity plans, regardless of which planning approach is adopted for a region. In fact, it is likely that all plans will contain some combination of conservation, local generation, transmission, and distribution elements. Once the decision on the basic approach is made, the plan is developed around that approach, which affects the relative balance of conservation, generation, and “wires” in the plan.

8.1.1 Delivering Provincial Resources

Under a “wires” based approach, the long-term needs of Brant Area would be met primarily through transmission and distribution system enhancements. If the substantial needs forecast under the higher-growth scenario or additional industrial load arise, this could involve major new transmission development to deliver power from the major sources supplying the Area to where the power is needed.

Transmission options typically provide large capacity additions and can take 3-5 years to come into service from time of initiation. Such options could also require approval of leave to construct to the OEB as well as environmental assessments.

8.1.2 Large, Localized Generation

Addressing the Brant Area’s long-term needs primarily with large local generation would require that the size, location and characteristics of local generation facilities be consistent with the needs of the Area. As the requirements are for additional capacity during times of peak demand, a large generation solution would need to be capable of being dispatched when needed and to operate at an appropriate capacity factor. This would mean that peaking facilities, such as a simple-cycle gas turbine (“SCGT”) technology, would be more cost-effective than technologies designed to operate over a wider range of hours, or that are optimized to a host facility’s requirements.

Based on the long-term demand forecast, a local generation source could be helpful if it is located at Brant TS or Powerline MTS to further relieve the 115 kV sub-system. The cost of this option would depend on the size and technology of the units chosen, as well as the degree to which they can contribute to a provincial capacity or energy need.

8.1.3 Community Self-Sufficiency

Addressing the long-term needs of Brant Area through a Community Self-Sufficiency approach requires leadership from the community itself to identify opportunities and deploy solutions. As this approach relies to a great degree on emerging technologies, there will be a need to develop and test out solutions to establish their potential and cost-effectiveness, so that they can be appropriately assessed in future regional plans.

In the Brant Area, this approach will be led by municipalities, the LDCs and First Nations communities if desired in identifying and developing opportunities.

8.2 Recommended Actions in Support of Long-Term Plan

At this time, while the Working Group does not recommend any specific commitment of investment and facilities to address potential longer-term needs (beyond 2025). To prepare for potential longer-term electricity load growth in this Area, the Working Group will investigate opportunities and potential for further cost-effective conservation and generation, as well as any relevant transmission investments.

Monitoring of growth in electricity demand and the achievement of conservation and DG targets in the Brant Area, will also be key components of ongoing electricity planning in the region and the needs and the options in the longer term will be reviewed in subsequent Burlington-Nanticoke regional planning studies.

1. Monitor Load Growth and Conservation Achievement and DG Performance

On an annual basis, the IESO will coordinate a review of conservation achievement, the uptake of provincial DG projects, and actual demand growth in the Brant Area. This information will be used to track the expected timing of long-term needs to determine when a decision on the long-term plan is required. Information on conservation and DG performance will also provide useful feedback into the ongoing development of these options as potential long-term solutions.

Additionally, the IESO will monitor results and incorporate lessons learned from the DR pilot, if it is implemented.

As the long-term needs for the Brant Area becomes more certain, additional measures to meet these needs, including but not limited to, large infrastructure investments, can be triggered in the next planning cycle with appropriate lead times to ensure that the needs will be met.

2. Undertake community engagement

Broad community and public engagement is essential to development of a long-term plan. As no long-term needs have been identified for the Brant Area, there is no requirement at this time for engagement on long-term options.

However, a LAC may be established for the broader Burlington to Nanticoke region when the regional planning process is complete for the whole region.

A LAC's purpose is to provide input and advice on engagement plans for an area or region. It is expected that a LAC will consist of community, First Nations and Métis representatives and stakeholders. Advice from the LAC will be incorporated in developing engagement plans for an area/region.

3. Continue ongoing work to develop transmission/generation options

The IESO and Hydro One will continue working with the working group to evaluate the transmission or generation options to meet the potential long-term needs.

8.3 Recommended Actions and Implementation

A number of alternatives are possible to meet the region's long-term needs if they arise. While specific solutions do not need to be committed today, it is appropriate to begin work now to gather information, monitor developments, engage the community, and develop alternatives, to support decision-making in the next iteration of the IRRP. The long-term plan sets out the near-term actions required to ensure that options remain available to address future needs if and when they arise.

The recommended actions and deliverables for the long-term plan are outlined in Table 8-1, along with their recommended timing, and the parties with lead responsibility for implementation are assigned.

Table 8-1: Implementation of Near-Term Actions in Support of the Long-Term Plan for the Brant Area

Recommendation	Action(s)/Deliverable(s)	Lead Responsibility	Timeframe
1. Undertake engagement	Undertake public/community engagement as required	LDCs	2015-2017
	Engage with First Nations communities and the Métis Nation of Ontario	IESO	2015-2017
2. Monitor load growth, CDM achievement, and DG uptake	Prepare annual update to the Working Group on demand, conservation and DG trends in the Area, based on information provided by Working Group	IESO	Annually
	Identify long-term CDM potential	IESO	2016
3. Continue ongoing work to develop transmission / generation options	The IESO and Hydro One will continue working with the working group to evaluate the transmission or generation options to meet the potential long-term needs.	IESO/Hydro One	As required based on monitoring of growth
4. Initiate the next regional planning cycle early, if needed	Based on results of monitoring (see recommendation 4), commence the next regional planning cycle in advance of the OEB-mandated schedule, if needed, to enable sufficient time to develop options	IESO	As required

9. Community, Aboriginal and Stakeholder Engagement

Community engagement is an important aspect of the regional planning process. Providing opportunities for input in the regional planning process enables the views and preferences of the community to be considered in the development of the plan, and helps lay the foundation for successful implementation. This section outlines the engagement principles. It also addresses activities undertaken to date for the Brant Area IRRP and those that will take place to discuss the long-term needs identified in the plan and obtain input in the development of options.

A phased community engagement approach has been developed for the Brant IRRP based on the core principles of creating transparency, engaging early and often, and bringing communities to the table (see Figure 9-1). These principles were articulated as a result of the IESO's outreach with Ontarians to determine how to improve the regional planning process and they are now guiding the IRRP outreach with communities.

Figure 9-1: Summary of Brant IRRP Community Engagement Process

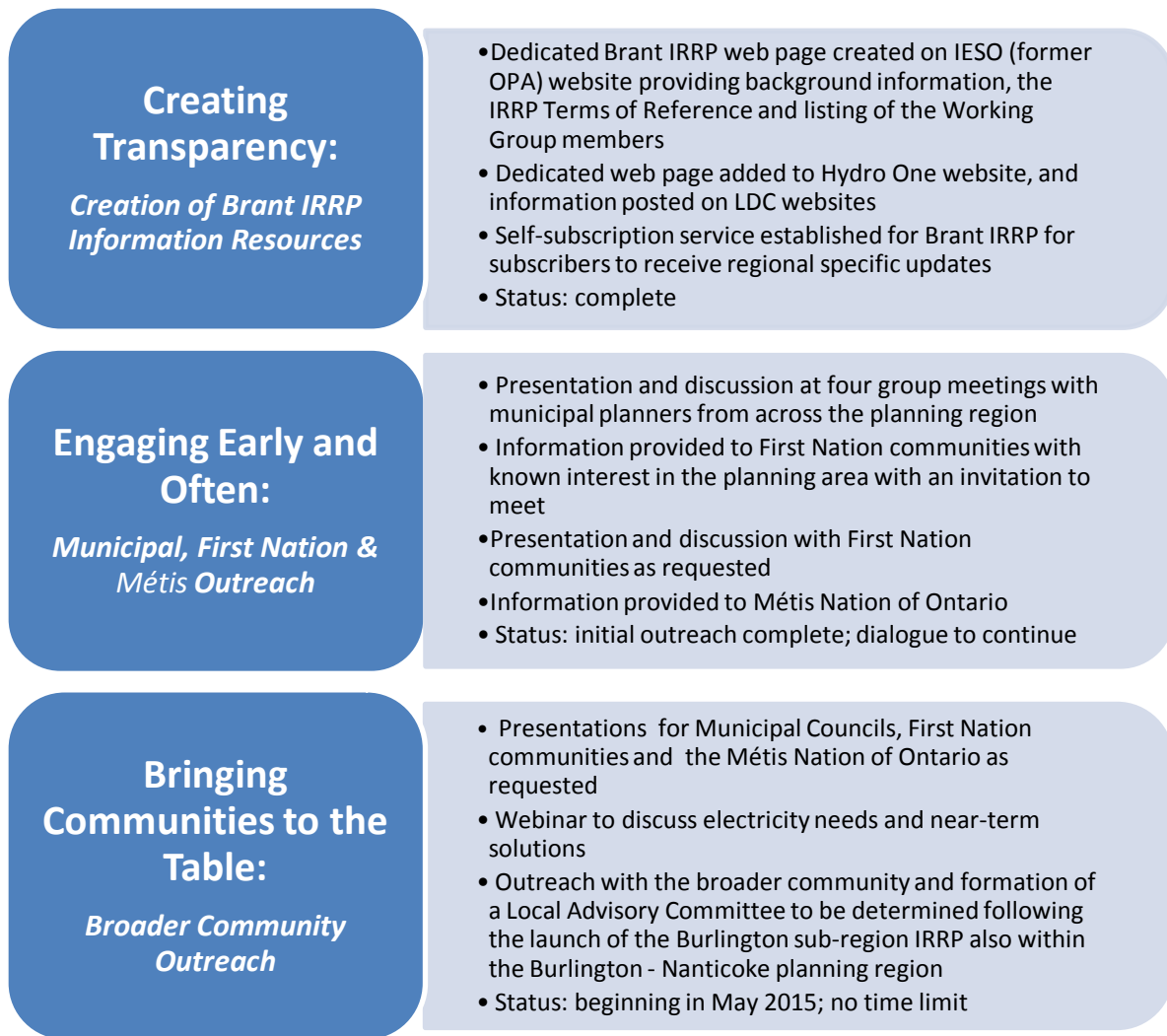

Creating Transparency

To start the dialogue on the Brant IRRP and build transparency in the planning process, a number of information resources were created for the plan. A dedicated web page was created on the IESO (former OPA) website to provide a map of the regional planning Area, information on why the plan was being developed, the Terms of Reference for the IRRP and a listing of the organizations involved was posted on the websites of the Working Group members. A dedicated email subscription service was also established for the Brant IRRP where communities and stakeholders could subscribe to receive email updates about the IRRP.

Engaging Early and Often

The first step in the engagement of the Brant IRRP was meeting with representatives from the municipalities and First Nations communities in the region. For the municipal meetings, presentations were made to the Brant Area municipal planners at two group meetings held in Brant and Brantford in 2013, and again in 2015 after Area load forecasts were updated due to expected increases in near-term demand. The IESO held a separate meeting with representatives of the Six Nations Elected Council.

During these meetings, key topics of discussion involved confirmation of increased growth projections for the Area, which included addressing the near- and medium-term needs through the installation of capacitor banks at the Powerline MTS and switching facilities at Brant TS, and continued CDM efforts, with the possibility of a DR pilot program in the Area, and potential actions to prepare for the long-term need if it materializes. Invitations to meet to discuss the Brant IRRP were also extended to the Mississaugas of the New Credit First Nation and to the Haudenosaunee Confederacy Chiefs Council. The IESO remains committed to responding to any questions or concerns from other communities who may have an interest in the planning Area.

Information on these project-level engagements, if required, will be provided on Hydro One's website and will also be listed on the IESO's Brant IRRP main webpage.

Bringing Communities to the Table

This engagement will begin with a webinar hosted by the working group to discuss the plan and potential approaches of possible long-term options. Presentations on the Brant IRRP will also be made to Municipal Councils, First Nations communities and the Métis Nation of Ontario on request.

Decision on broader community outreach activities, including whether to form a LAC will be made after the launch of the Bronte sub-region IRRP that is also within the Burlington – Nanticoke planning region. As LACs are generally formed at the regional planning level, not the sub-region level, additional work is required on the Bronte sub-region IRRP prior to initiating the formation of the LAC. In general, LACs are established as a forum for members to be informed of the regional planning processes. Their input and recommendations, information on local priorities, and ideas on the design of community engagement strategies will be

considered throughout the engagement, and planning processes. Local Advisory Committee meetings are open to the public and meeting information is posted on the IESO website.

Strengthening processes for early and sustained engagement with communities and the public were introduced following an engagement held in 2013 with 1,250 Ontarians on how to enhance regional electricity planning. This feedback resulted in the development of a series of recommendations that were presented to, and subsequently adopted by the Minister of Energy. Further information can be found in the report entitled “Engaging Local Communities in Ontario’s Electricity Planning Continuum”¹² available on the IESO website.

Information on outreach activities for the Brant IRRP can be found on the IESO website and updates will be sent to all subscribers who have requested updates on the Burlington to Nanticoke IRRP.

¹² <http://www.powerauthority.on.ca/stakeholder-engagement/stakeholder-consultation/ontario-regional-energy-planning-review>

10. Conclusion

This report documents an IRRP that has been carried out for the Brant Area, a sub-region of the Burlington to Nanticoke planning region.¹³ The IRRP identifies electricity needs in the Area over the 20-year study period from 2014 to 2033, recommends a plan to address near- and medium-term needs, and identifies actions to develop broad options for the long term.

Implementation of the near-term plan is already underway, with the LDCs developing conservation plans consistent with the Conservation First policy and infrastructure projects being developed by the LDCs and Hydro One.

To support development of the long-term plan, a number of actions have been identified to monitor growth, engage with the community, and develop alternatives in the Area, and responsibility has been assigned to appropriate members of the Working Group for these actions. Information gathered and lessons learned as a result of these activities will inform development of the next iteration of the Brant Area IRRP. A RIP is not required because transmission infrastructure planning to address the needs identified are already at the project level.

The planning process does not end with the publishing of this IRRP. Communities will be engaged in the development of the options for the long term. In addition, the Working Group will continue to meet regularly throughout the implementation of the plan to monitor progress and developments in the Area and will produce annual update reports that will be posted on the IESO website. Of particular importance, the Working Group will track closely the expected timing of the needs that are forecast to arise in the long term under the higher-growth scenario or arrival of additional industrial load. If demand growth follows the expected-growth scenario or conservation achievement is higher than forecast, the plan may be revisited according to the OEB-mandated 5-year schedule. This outcome would allow more time to develop alternatives and to take advantage of advances in technology in the next planning cycle.

¹³ The Brant and Bronte area of Oakville and Burlington form part of the larger Burlington to Nanticoke region.